

Installation Manual



WLM2



WLTA



WLTD



WLTP



WLCT



QUICKGUIDES

Quickguides	Page 3
Quick Installation Guide.....	Page 3
Setting up the System.....	Page 5
Wireless system only.....	Page 5
Testing the system.....	Page 6
Troubleshooting.....	Page 7

INSTRUCTIONS

WLM Underfloor Heating Controller	Page 10	Add On Module	Page 31
Wiring diagram.....	Page 10	Configuring the Total System.....	Page 31
Description.....	Page 13	Outdoor Compensation Module	Page 32
Product programme.....	Page 13	Introduction.....	Page 32
Technical data.....	Page 13	Mounting.....	Page 32
Environment.....	Page 14	Bus connection - Outdoor	
Recycling of obsolete appliances.....	Page 14	compensation module.....	Page 32
Configuring of the total system.....	Page 14	Interconnection of WLM2 product.....	Page 32
Installation	Page 15	Waterline Wireless System	Page 33
Electrical installation.....	Page 15	Product Programme.....	Page 33
Boiler demand.....	Page 15	Connection of Master and Receiver.....	Page 33
Pump output.....	Page 16	Position.....	Page 33
Free relay function (X-OUTPUT).....	Page 16	Master.....	Page 33
Thermal actuators.....	Page 17	To set up the system.....	Page 33
External switch for night setback.....	Page 18	Type WLCT	Page 34
Room sensors - Bus connection.....	Page 18	Introduction.....	Page 34
Room sensors - Wireless setup.....	Page 19	Getting started.....	Page 34
Setting up which Room sensor/controller		Daily Use of the room sensor.....	Page 36
should work with which thermal actuator.....	Page 20	Programming 4-Event Clock Time	
Supply water temperature sensor		and Temperature.....	Page 37
and mixing value.....	Page 21	Advanced Settings and Read-out.....	Page 38
Creating a Network	Page 22	Reset to factory Settings - room controllers.....	Page 41
Using cooling function.....	Page 23	Waterline Room sensors	Page 42
Domestic hot water control.....	Page 23	Introduction.....	Page 42
Radiator control.....	Page 24	Set-up.....	Page 43
2 step heating.....	Page 24	Setting of Room Temperature.....	Page 44
Commissioning mode.....	Page 25	Setting of Room sensor Operating Mode.....	Page 44
Replacing equipment.....	Page 25	Limit Sensor - WLTD and WLCT.....	Page 45
Guidelines and special features.....	Page 26		
Factory default settings.....	Page 27		
Error indication.....	Page 28		

QUICKGUIDES

QUICKGUIDES

QUICK INSTALLATION GUIDE

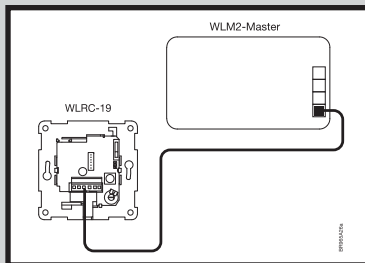
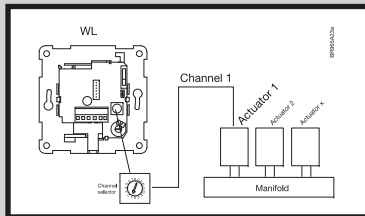
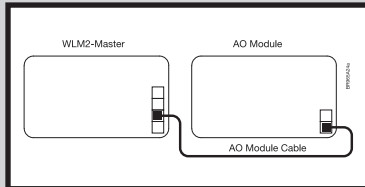
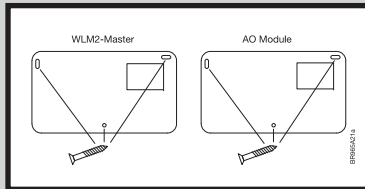

We recommend the preparation of an area schedule chart on the backside of the user manual before commencing the installation. This identifies piping circuits to specific rooms and enables the correct allocation of a channel number in the WLM system.

1

Mount the Master and AO modules in the correct way on the wall in accordance with electrical regulations.

2

Connect the AO-module, using the special cable included in the box.

3

Mount the Room sensors/controllers in the rooms, and set the channel switches to correspond with the number of the actuator controlling that room.
For hardwired Room sensors/controllers now connect the 2-wire bus to the master or the AO module, maintaining continuity of positive + and negative - connections.
For wireless Room sensors/controllers now insert the batteries.

NB: For Room sensors with floor temperature limiting sensors, please refer to separate instructions included with Room sensors/controllers.

4

If the Room sensors/controllers are of wireless type connect the receiver (WLRC-19) using the special cable enclosed with the receiver.

B	A	--	+
Blue	Red	Brown	Yellow

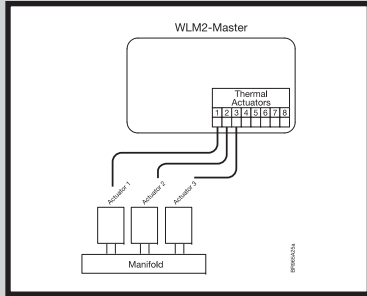

5

Connect the actuators to the channel outputs on the master in accordance with the pipe manifold layout (please refer to the area schedule).

Actuator no. 1 on the manifold to output no. 1 on the master.
Actuator no. 2 on the manifold to output no. 2 on the master.
etc.

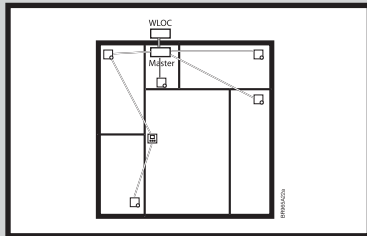

6

Outdoor module WLOC-19 (FS Master only):

Install on north facing wall, away from direct sunlight.

Connect into 2-wire Room sensor bus or direct to master, maintaining continuity of positive + and negative - connections.

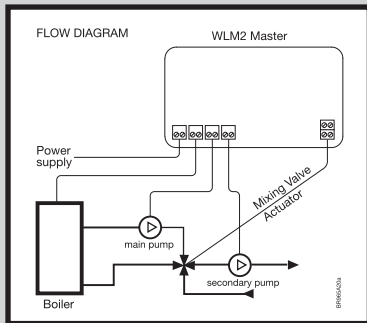

7

Connect 230/240Vac power, UFH circulating pump and boiler in accordance with electrical regulations.
(For FS masters, connect the mixing valve and water flow temperature sensors)

SETTING UP THE SYSTEM

1. Turn on the power supply.
2. Set the clock on any WLCT room controller:
 - a. If the hour digit is not flashing, press the small pinhole button with the clock symbol, otherwise..
 - b. Adjust the hours and press OK.
 - c. Adjust the minutes and press OK.
 - d. Adjust the day number (1 = Monday) and press OK.
3. In addition to its own room, the WLCT room controller can be used to set the operating times and temperatures of other Room sensors (channels).
 To achieve this, do the following on the WLCT room controller:
 - a. Enter the "InFo" menu by pressing the up and down button simultaneously for 4 seconds.
 - b. Find the "ArEA" menu with the down button and press OK.
 - c. The display shows "CH 1" (channel 1).
 - Press OK button.
 - Select "On" if this channel (Room sensor) should be controlled by the WLCT room controller, or "OFF" if not.
 - Now press OK button to get to the next channel (CH 2) and repeat this step until all required channels have been selected "On".
 - d. After all channels are set up, find the "ESC" menu entry and press OK.

NB: If different times and temperatures are required for other channels (Room sensors) within the system, more than one WLCT room controller can be used. Care must be taken to ensure that the action of selecting a channel "On" is not made on more than one WLCT room controller.

WIRELESS SYSTEM ONLY:

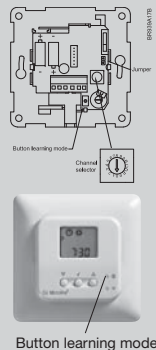
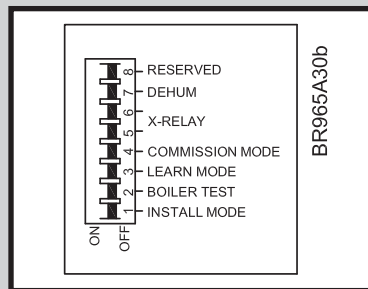

Button learning mode

1. Switch on DIP-3 to activate learn mode:
2. All wireless Room sensors now have to be initialized:
 - Analogue Room sensor (TA,TD,TM,TP) by pressing the internal init button (Button learning mode) until a beep is heard.
 - Digital Room sensor (CT) by pressing the pin hole button with the clock symbol until a beep is heard.
3. Switch off DIP-3 to de-activate learn mode:

TESTING THE SYSTEM:

- 1.** Switch on DIP-3 to activate learn mode: - power light will blink quickly
- 2.** Each red channel light on the master should now be lit if a Room sensor is present on that channel.
- 3.** Switch off DIP-3 to de-activate learn mode again – power light stops blinking.
- 4.** Turn all adjustable temperature settings on the Room sensors to minimum.
- 5.** Switch on DIP-1 on the master to activate install mode (Install mode will be active for 2 hours
- Pumps, boiler, mixing valve and actuators should now be off)
- 6.** Turn the temperature setting on the adjustable Room sensor in room 1 to maximum. The red channel 1 light should be lit and the actuator on output nr. 1 will be activated, and will open after 1-3 minutes, depending on the type of actuator.
Important: If the Room sensor is of a wireless type a delay of up to 5 minutes may occur before the channel light becomes illuminated .
- 7.** Check that the UHF pump is running and the mixing valve (only FS master) opens .
- 8.** Repeat step 6 on all rooms.
- 9.** Boiler test function:
Switch on DIP-2.
This closes the boiler start relay contacts for 1 minute.
- 10.** To end all tests:
 - Switch off DIP-1 to deactivate install mode.
 - Switch off DIP-2 to deactivate boiler test.
 - Set all temperature knobs to default positions
 - Room sensors (TA,TD,TM,TP) to zero (center position).
 - Room controllers (CT) recommended to 21°C.
 - Set all override switches on TM and TD Room sensors to automatic position (clock symbol).
- 11.** The system is now operating automatically.

NB: Other important settings can be found in the User manual on the pages shown below:

Off temperature (frost protection)	page 7
Minimum & Maximum floor temperatures	page 7
Maximum supply water temperature	page 8
Weather compensation	page 8

TROUBLESHOOTING:

Problem

Possible cause & solution

Channel light is not coming on.
(When in Learn mode)

Make sure the power light is fast blinking. If not then put DIP-3 to ON position.

2-wire bus may be incorrectly connected. Voltage at each Room sensor should not be lower than 4.0V (check for + & - continuity and short circuits)

For wireless Room sensors, please check that the batteries have been inserted correctly.

Has the init button been pressed ?

For wireless Room sensor check that the WLRC-19 (receiver) is correctly connected.

For channel 9-14, is the AO module correctly connected to the Master.

Make sure the Room sensor in that room is set to the correct channel number.

The channel selector on the Room sensor may be slightly out of position, try rotating and the set it again.

(When in Install mode, when the Room sensor is activated (set to maximum))

.....

Master is not in install mode – after 2 hours the master automatically de-activates install mode – please reset the DIP-1.

Make sure the Room sensor in that room is set to the correct channel number. (two Room sensors could be crossed over)

The actuator on the manifold has not opened after 3 minutes.

Check the red channel light is illuminated.

The actuator for the room is not connected to the correct output on the master.

Bad electrical connection between actuator and terminals.

Actuator may be faulty or manually locked.

UFH Pump not starting in install mode

Bad electrical connection between pump and terminals.

Install mode is not activated.

Pump may be faulty.

Output relay for Main pump, Cooling, High limit valve or other attached device.

Incorrect connection to device (output relay has volt free contacts, see master wiring diagram for correct connection)

Bad electrical connection between terminals and attached device.

Install mode is not activated.

Attached device may be faulty.

Boiler does not fire
(LED lit)

Incorrect connection to device (output relay has volt free contacts, see master wiring diagram for correct connection)

Bad electrical connection between terminals and attached device.

Install mode is not activated.

Attached device may be faulty.

(LED not lit)

Timing sequence delay is activated

FS master only - mixing valve not open above 20%

No heat demand from Room sensors.

Master is in cooling mode.

Mixing valve does not operate correctly
(When in install mode)

Incorrect connection, see master wiring diagram for correct connection.

Valve/actuator assembly is incorrect.

Actuator is faulty.

Check what happens if sensor and/or outdoor module is missing.

(Valve cycles between open and closed in normal operating mode)

Valve may be oversized.

Supply Limit sensor may be subject to heat migration.

Upstream water temperature is excessively high.
(these problems may be corrected by changing PI settings – please refer to the main manual)

Room is too cold.
(After running for at least 48 hours)

The Room sensor is placed in a position that does not represent the general temperature in the room. E.g. mounted on external wall or near an extraneous heat source.

If the room is controlled by a CT Room sensor, check that the time and temperatures are set correctly.

If the Room sensor has got an override switch (TM or TD), the switch may be set in the "off" or "night" position.

For rooms with floor sensors, the maximum floor limit setting could be preventing the room reaching the desired temperature.

Insufficient heating capacity of the system.

Bad insulation creating large heat loss.

Room is too hot
(After running for at least 48 hours)

This could be caused by draughts within the wall cavities.

The Room sensor is placed in a position that does not represent the general temperature in the room.

If the room is controlled by a CT Room sensor, check that the time and temperatures are set correctly.

If the Room sensor has got an override switch (TM or TD), the switch may be set in the "day" position.

For rooms with floor sensors, the minimum floor limit setting could be increasing the room temperature above the desired setting.

Solar gain or extraneous heat source.

INSTRUCTIONS

WLM Underfloor Heating Controller

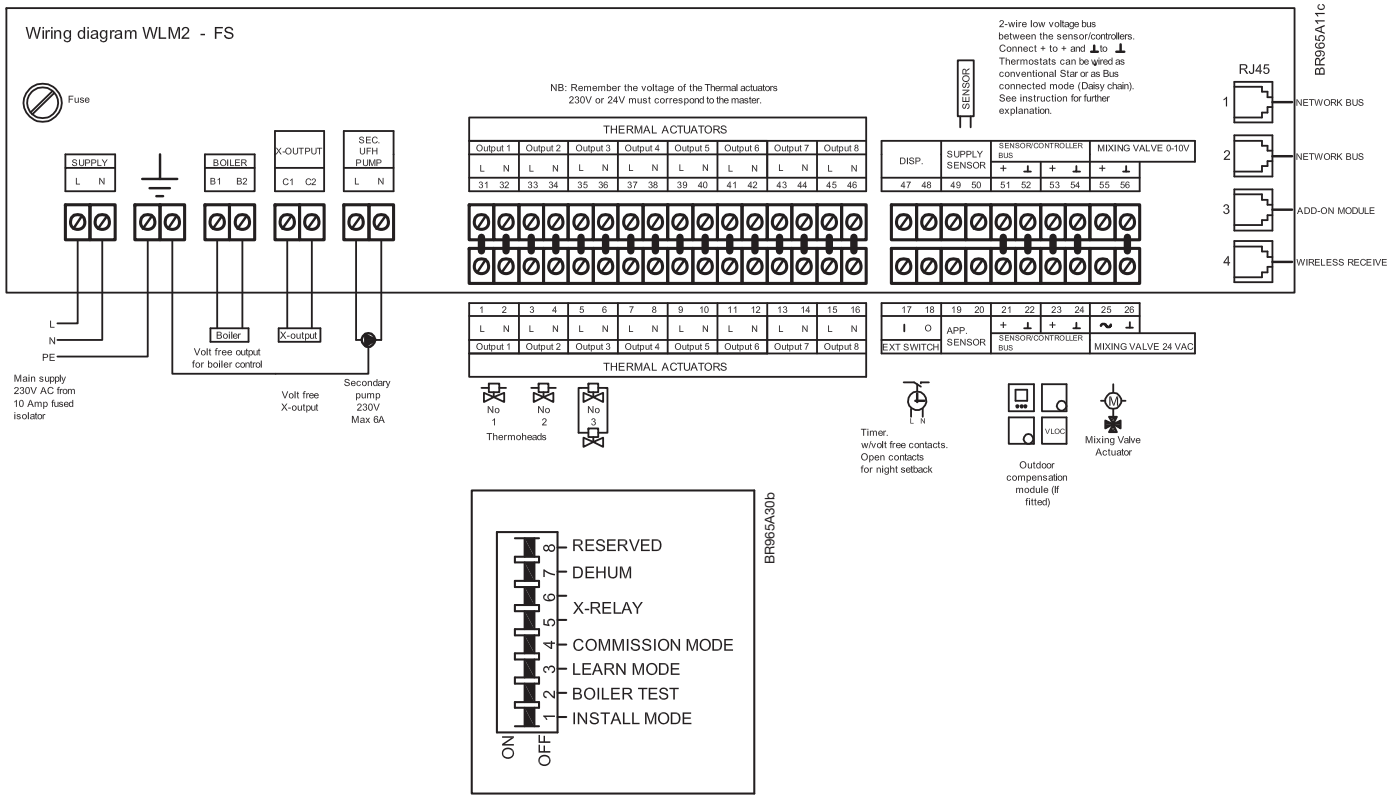

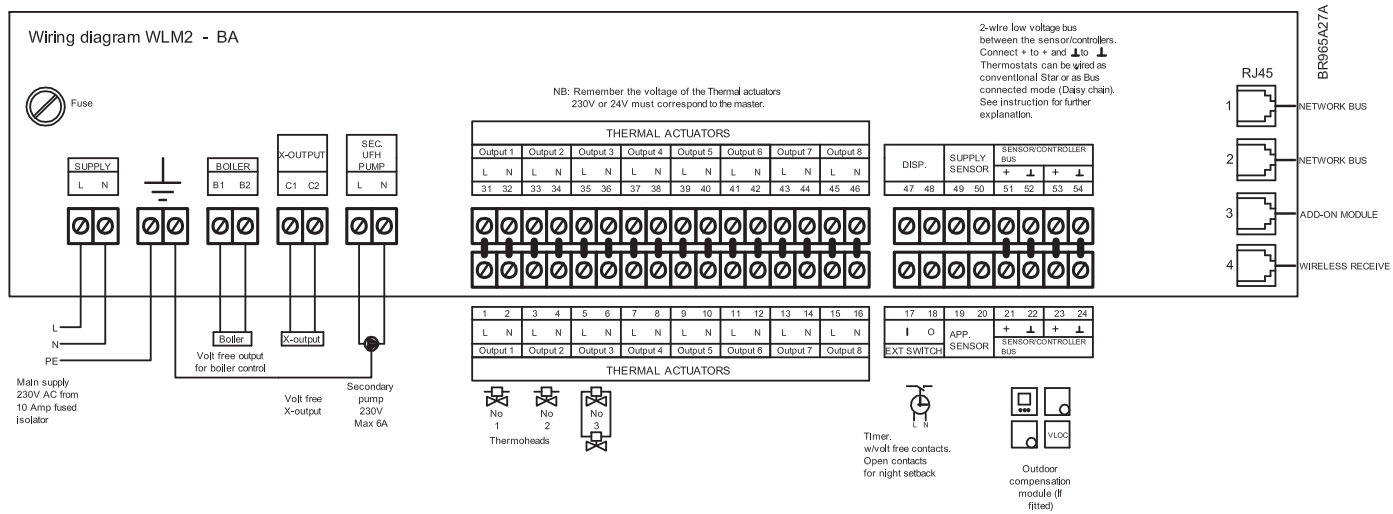

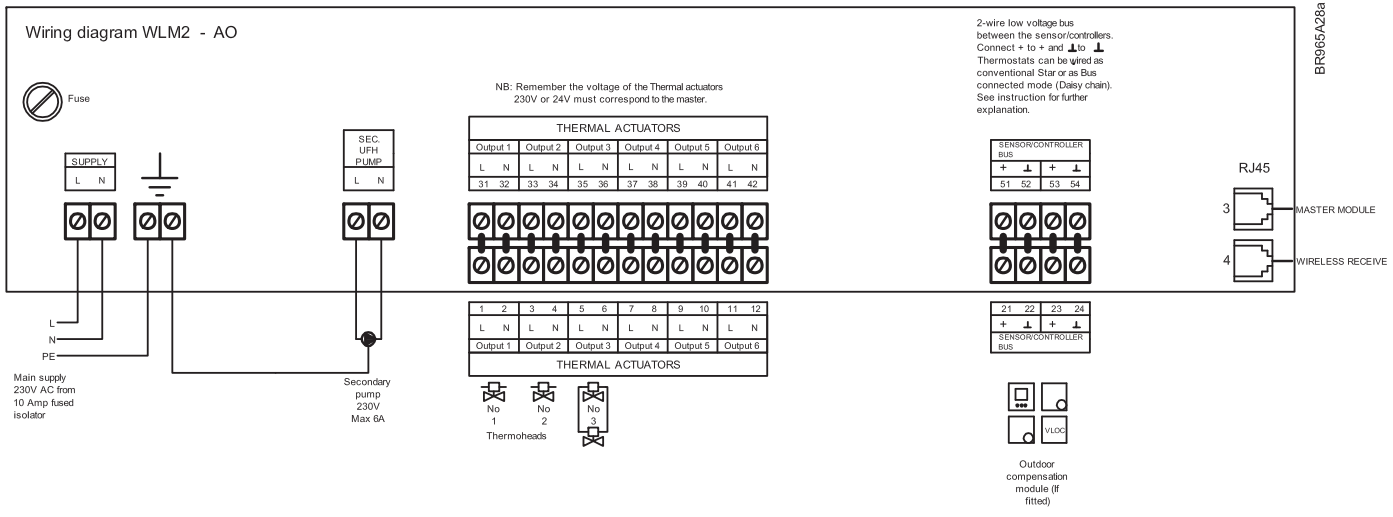

Environment

Please help us to protect the environment by disposing of the packaging in accordance with the national regulations for waste processing.

Recycling of obsolete appliances

Appliances with this label must not be disposed off with the general waste. They must be collected separately and disposed off according to local regulations.

Configuring the Total System

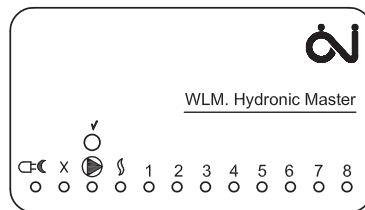

Type WLM-1BA and WLM-3BA

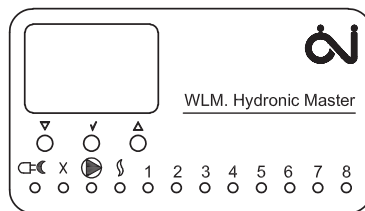

Type WLM-1FS and WLM-3FS

BR0965A04

Each master module is capable of controlling 8 heating zones, each of which may use one or more loops of piping, with one or more thermal actuators. These zones are referred to later in this instruction as channels 1 to 8. If you wish to control more than 8 zones, it is necessary to install ADD ON (AO) modules, each of which can provide another 6 outputs. The first AO module then controls channels 9 to 14,

BR0965A03

- Green: Power supply connected
- Red: Night setback active
- Red flashing: Indicates error
- X Main boiler (primary) pump is running (if installed)
- Secondary UFH pump is running
- Boiler enable signal is activated
- 1..8 Zone 1 to 8 indicating heating is on

INSTRUCTIONS

Installation

Fit the WLM master to a suitable wall. It will generally be found more convenient if the unit is within 0.8 metre of the manifold, as most thermal actuators are supplied with 1m cables. Cables can be run on the surface into the terminals using either the cable releases in the cover or by pressing out the cable entries in the lower part of the cover.

Electrical Installation

Fig. 3

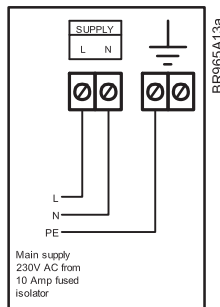

PLEASE ENSURE THAT ALL WIRING IS CARRIED OUT IN ACCORDANCE WITH LOCAL ELECTRICAL REGULATIONS.

When wiring is completed, fit the cover on the master using the screws provided.

Mains supply

WLM requires a 230V AC mains supply connected to the terminals marked L, N, & E.

Boiler Demand

Fig. 4

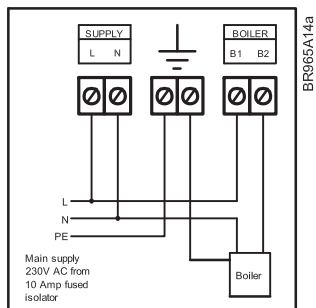

The master has a volt-free relay output that can be used to control a boiler, or to open a motorised valve.

A) To control a boiler that requires switching of the live supply, take a link from L (230V) to the terminals marked BOILER - B1. Connect the boiler L to the terminal marked BOILER - B2. Connect the boiler N terminal to the N terminal on the master, and the boiler E to the master terminal E. (see fig. 7A).

B) To control a boiler that has a pair of dedicated terminals for remote switching (e.g. by a Room sensor), connect these terminals to B1 and B2 on the master. B1 and B2 terminals are "volt free" so they can be used for both a 240V and a 24V circuit from the boiler.

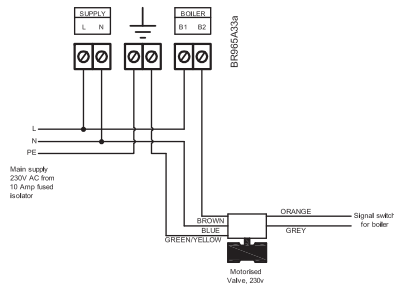

C) To control a motorised valve:

Many motorised valves have wires coloured BROWN and BLUE for power connections. In this case BROWN goes to the terminal B2 under the heading BOILER and BLUE goes to the N terminal of the master. Then a link from L (230V) to the terminals marked "Boiler B1". The boiler relay will be energised after a delay of 10 sec after the start of the main pump.

Basic versions without display. Type WLM2-1BA and WLM2-3BA The boiler relay will stop if there is no heat demand measured by the Room sensors.

Versions with display. Type WLM2-1FS and WLM2-3FS. These units have supply water temperature control, and the boiler relay will be ON once the control valve has reached 20% open, and will remain on as long as a heat demand exists.

Pump Output

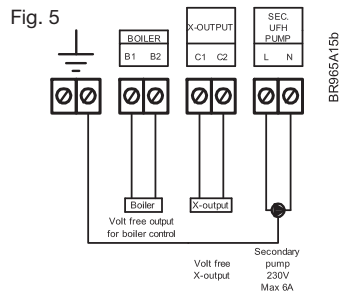

The master has an output for the underfloor circulating pump (secondary pump). The output will be energised after a 180 sec. delay when any connected room sensor calls for heat. The delay is to allow time for the thermal actuator to start opening.

The 230v AC pump can be connected directly to terminals L and N under the heading "Sec. UHF Pump". Connect the pump E (Earth) terminal to E (earth) on the master. The maximum pump load must not exceed 4 amps , 230v at start up. There is an overrun period of 1 minute after the demand for heat from the room sensor disappears.

Delay times: Secondary UHF pump 180 sec.
X-output (configured as main pump) 190 sec.

Free relay function (X-OUTPUT):

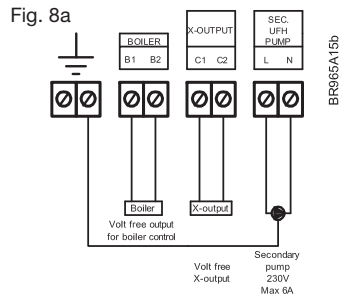

All WLM master have a relay which can be utilized for a number of different purposes.

The relay is a volt free output and is positioned on the PCB as shown on the drawing.

The function of the relay is determined by the setting of the DIP-switches.

The functions that the relay can perform, and the appropriate DIP-switch settings, are as follows:

To control:	Dip-5	Dip-6
Boiler pump	Off	Off
High limit zone valve*	On	Off
Cooling device/module**	Off	On
Cooling device/module alternative	On	On

The X relay output is volt free as shown in fig 8a. If the relay is required to be used as a L & N switch, connect a link wire from mains L to C1, connect the device L to C2, and the device N to mains N.

Boiler pump:

Where a boiler primary pump is required to be switched on from the master, the relay output can be used for this purpose. The relay will be activated 10 seconds after the UFH circulating pump has started.

High Limit Zone Valve:

This function is used where an additional protection is required to prevent boiler water entering the underfloor system, when the system is off or when the supply water exceeds 65 C. An additional sensor (ETF-1899A) and a zone valve is connected as per attached pic.

Cooling device/module:

The relay output can be used to provide a volt free signal to a heatpump, or to a K-MOD switching module where a chiller is utilized to provide the cooling water. The relay is on when there is a cooling demand.

Cooling device/module alternative:

The relay output is always on in cooling mode and off in heating mode.

Thermal Actuators [Thermoheads]

Fig 6

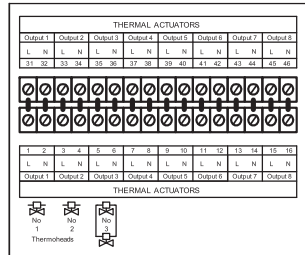

These actuators are fitted to the underfloor heating manifolds and control the supply of water through the various loops. The voltage of the thermal actuators, 230V or 24V, must correspond to the master. Master type WLM-1BA and WLM-1FS are for 230 V thermal actuators, and master type WLM-3BA and WLM-3FS are for 24V Thermal actuators. Up to 8 different zones can be controlled by the master. Connect the thermal actuators on the loop(s) for each zone to the corresponding terminals on the master. Thermal actuators belonging to zone 1 must be connected to output terminal 1, and thermal actuators for zone 2 must be connected to output terminal 2, etc, etc.

Guideline

More than 1 head can be connected to a single terminal, provided that the heads are to be controlled by the same room Room sensors. Connect the Brown wire to the L terminal, and the Blue wire to the N terminal. When the installation is complete, check that the Room sensor in e.g. room(zone) 1, operates the correct thermo actuator(s) for that room on the manifold. If the heads appear to be in the wrong position on the manifold, it may be simpler to change them on the manifold, rather than reconnecting them on the master.

External Switch (TIMER) for night setback

Fig 7

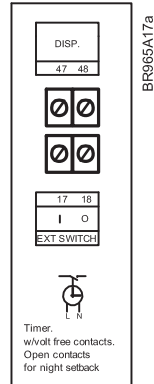

From factory the master is delivered with a jumper in the switch/ timer terminals I & O. The day temperature setpoint is defaulted to 20°C and the night temperature to 15°C. These default settings can be changed if the master has a display. The current operating set point of the master can be changed from the day temperature into night temperature, and vice versa by using an input from an external switch or timer. The input must be a volt free switch, and will need to open circuit for night temperature and close circuit for day temperature. When the external switch or timer is used to switch to night setback, this will override any time settings in a WLCT Room controller, including any Room sensors that are part of a group allocated to that Room controller.

Room sensors - Bus Connection

Fig 9

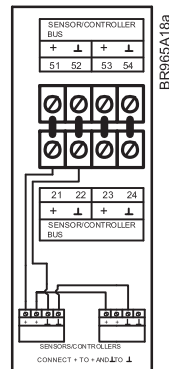

Only OJ Room sensors type WLxx that are prepared for 2 wire communication can be used. Standard installation cable, maximum 2 x 0.25 mm² can be used. The Room sensors can be connected in the conventional star wiring format, or in a bus connected mode (Daisy chain) see fig 10 + fig 11. The master has 4 sets of terminals marked Room sensor BUS that can be used for connecting the 2-wire signal from the Room sensors.

There are 4 identical sets of terminals for convenient installation. Any Room sensor can be connected to any pair of terminals. The total length of the 2-wire system can be up to 300 m with a maximum length of 100m between any 2 Room sensors. Remember to connect + to + and - to -.

SENSORS/CONTROLLERS CONNECTED IN STAR

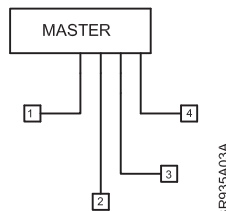

Fig 10

SENSORS/CONTROLLERS CONNECTED IN BUS MODE (DAISY CHAIN)

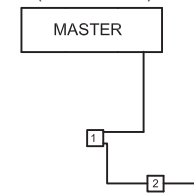

Fig 11

Room sensors - Wireless setup:

Fig 12

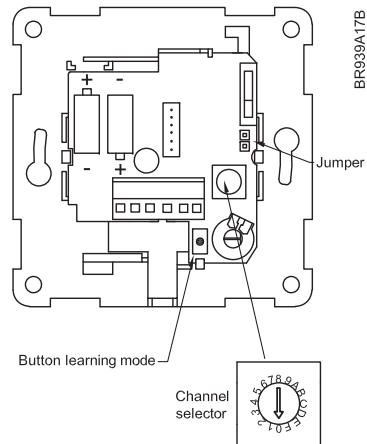

Fig 13



Where wireless Room sesors/controllers (WLTx-29) are being used is necessary for the WLM master to “learn” that the Room sensors/controllers are communicating correctly.

To achieve this:

1. On master, switch on DIP-3 to activate learn mode:
2. All wireless Room sensors/controllers now have to be initialized:
 Room sensors (WLTA, WLTD, WLTM, WLTP) by pressing the internal init button (Button learning mode) until a beep is heard. (see fig. 12)
 Room controllers (WLCT) by pressing the pin hole button with the clock symbol until a beep is heard. (see fig. 13)
3. Switch off DIP-3 to de-activate learn mode.

Setting up Which Room sensor Should Work With Which Thermal Actuator

Fig 10

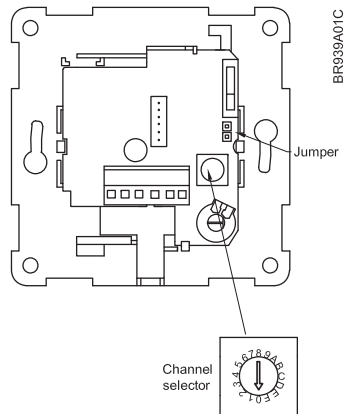

Each Room sensor can be selected to operate a specific output which in turn controls the thermal actuators on the manifold. Under the front cover of the Room sensor, a selector can be accessed, and the number of its output (its CH channel) can be set with a screwdriver. (See fig 10) Up to 14 channels can be set on the selector, and there are two auxiliary channels. (see later). A WLM master has 8 outputs and additional slave module 6 outputs, and can be connected creating a system of 14 individual zones.

Please note that channels 10 to 14 are marked as A through E on the selector,

A Room sensor set for CH1 will activate the thermal actuator connected to output 1 on the master. The channel number can be selected without any power connected to the system. The channel of the Room sensor can be changed afterwards if needed. If two Room sensors are placed in the same room and set to the same channel, the temperature control will work according to the average temperature of both Room sensors.

Channel 0:

Each Room sensor is delivered with the switch in position 0 ensuring that it must be set to operate correctly. Channel 0 can also be used for a Room controller controlling a group of Room sensors where the control position should be somewhere central, e.g. the kitchen, rather than in the area where the Room sensors are installed. Setting it to Ch 0 means that times and temperatures are set on the WLCT for the group, but that the WLCT will not control a specific output itself.

Channels 1..14:

A Room sensor set for channel 1 will activate the thermal actuator connected to output 1 on the master. If several Room sensors are set to the same channel number, they will control in the following way,

- The actual room temperature is calculated as an average.
- The room temperature set point is calculated as an average.
- If a limit sensor is connected to the Room sensors

The lowest value of any Limit sensor is taken as the MIN Limit Temperature.
The highest value of any Limit sensor is taken as the Max Limit Temperature.

Channel 15 (position F on the switch) Party and vacation function.
Special function see FUNCTIONALITY.

Supply water temperature sensor and mixing valve

Fig 11

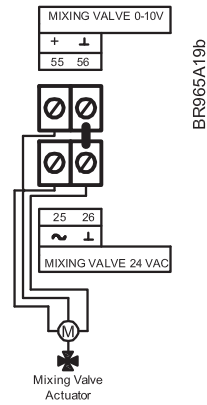

Supply water temperature limit sensor

This feature is not available on the basic master's version WLM2-1BA and WLM2-3BA. The limit sensor is directly connected to the master at the terminals marked limit sensor. Sensor type ETF-1899A must be used. The temperature sensor should be placed on the supply water pipe to the underfloor heating system. If a limit sensor is installed, without a weather compensation module (WLOC) the master will control the maximum water temperature. The factory default setting is 55°C, but this value can be changed via the display. If a weather compensation module (WLOC) is added to the system, the master will vary the supply water temperature setting based on the outdoor temperature. A standard compensation curve has been programmed at the factory. If needed the curve can be changed, see separate USER MANUAL, MASTER TYPE WLM2.

Mixing valve actuator control

Control of a mixing valve actuator is possible using the digital masters WLM2-1FS and WLM2-3FS

The actuator must be 24Vac powered (max 6VA) and positioned via the 0-10V DC signal, and should be configured so that it closes the valve if there is no heating demand (0Vdc signal). The control signal can be reversed to 10-0V via the master menu system if required.

Control action of the mixing valve actuator is P + I and the parameters can be changed if required in the master menu system.

Please contact the supplier for further instructions.

INSTRUCTIONS

Creating a Network

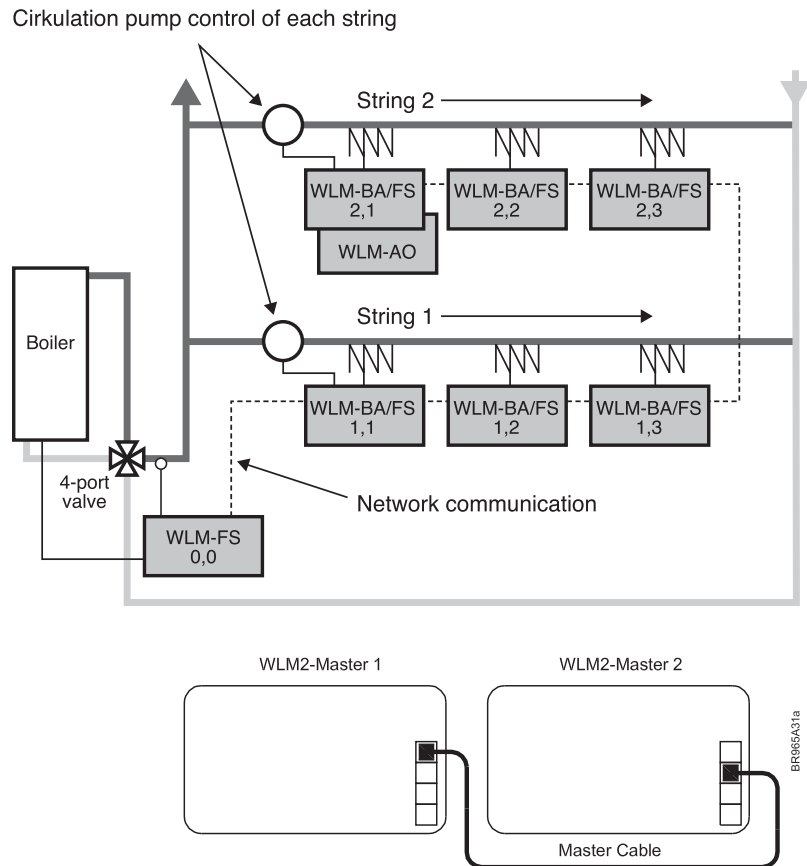

In large buildings with more than 14 zones where multiple manifolds are utilized, it is possible to use multiple masters to create a single network.

One master must be defined as the “network controlling master” by setting both encoders to zero (see pic).

Subsequent masters (up to nine) should be connected as a “string”, where they will all use a common pump.

If more than one pump is used, a separate string should be created for each pump. (see drawing below)

On the first string all left hand encoders must be set to 1, and the right hand encoders should be set in sequence from 1 to 9.

On the second string of masters all left hand encoders should be set to 2, and the right hand encoders again should be set in sequence from 1 to 9.

This numbering can be continued for up to 15 strings.

All masters are interconnected using special cable via the RJ45 socket 1 or 2.

The last master of the first string must be connected to the first master of the second string etc. etc.

An FS master can be used as the “network controlling master” for central mixing control of supply water and boiler switching.

Switching between cooling and heating can be done for the whole network on the “network controlling master” using the WLAC-1 interface module connected to the thermostat bus.

Using cooling functions

In addition to controlling heating, all WLM2 masters have the ability to control the system for cooling.

- To enable the cooling function an interface module WLAC and humidity sensor WLH have to be connected.
- On BA masters it is also necessary to install a sensor (ETF-1899) on the return water pipework from the floor for dewpoint control.
- The WLAC must be fixed in a convenient position for the user, and connected to the sensor/controller bus as shown in the picture (pic).
- If a BMS system is being used for the heating/cooling decision, the volt free BMS signal should be connected to WLAC but the slider switch on the right side of the WLAC must be set to the heating position (in this situation the BMS signal has priority and we recommend that the slider toggle be removed to avoid incorrect overriding)
- By using the humidity sensor WLH the system limits the formation of condensation on floor surfaces due to high humidity.
- The WLH must be fixed in a room that represents the general humidity level in the building, and connected to the sensor/controller bus (more than one WLH can be used if necessary e.g. on separate floors of the building). Where more than one humidity sensor is used, the master will take the reading of the sensor detecting the highest humidity level for the controlling action.
- If a dehumidifier is being used it can be connected via a relay using number 1 output on the master and setting DIP-7 to "on".
(Note: This output gives either 24Vac or 230Vac depending on the WLM2 master type. Channel number 1 cannot be used for Room controller control in this situation)
- When cooling is enabled the cooling set point will be pre-determined by the master and will override any settings in any Room controller to ensure optimum energy efficiency.
(The cooling set point will be +3C above the master day set point)

Domestic hot water control:

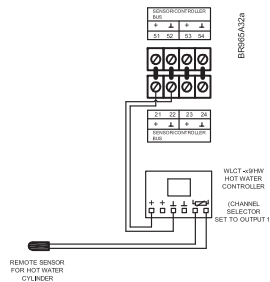

It is possible to control the domestic hot water temperature with a special Room controller (WLCT/ HW) to ensure optimum energy saving. A hot water sensor is connected to the Room controller and measures the temperature in the storage cylinder. A zone valve is then controlled via the WLM2 master, which in turn activates the boiler on demand.

- Install the hot water sensor (ETF) on the hot water take off pipe immediately above the storage cylinder. Use the fixing strap to mount it tight to the surface.
- The WLCT/HW must be fixed in convenient position for the user
- Connect the hot water controller WLCT2/HW to the WLM2 master using the sensor/controller bus.

- Connect the hot water sensor to the controllers sensor terminals.
- Connect the hot water zone valve to an output on the WLM master and set the channel number on the hot water controller to the corresponding number.

Note: When the WLCT/HW calls for heat it does not start the circulation pump on the under floor heating system

Radiator control:

It is possible to control a radiator circuit room temperature with a special Room controller (WLCT/R) to ensure optimum energy saving. The Room controller measures the temperature in the room, and a zone valve is then controlled via the WLM master, which in turn activates the boiler on demand.

- The WLCT/R must be fixed in a convenient position for the user, but which is representative of the room or area temperature.
- Connect the Room controller to the WLM master using the sensor/controller bus.
- Connect the radiator zone valve to an output on the WLM master and set the channel number on the Room controller to the corresponding number.

Note: When the WLCT/R calls for heat it does not start the circulation pump on the under floor heating system

2 step heating:

It is possible to control a of a secondary heat source in a room (e.g. a backup radiator), use the spesial mode in the WLCT/2 Room controller. In addition to the primary underfloor heating output, this WLCT/2 room controller is able to control a second output as a boost function, witch will be activated only if the temperature cannot be schieved by the underfloor heating within a preset time period.

- The WLCT/2 must be fixed in a convenient position for the user, but which is representative of the room or area temperature.
- Connect the Room controller to the WLM master using the sensor/controller bus.
- Set the channel number on Room controller to correspond with the output on the WLM master that is connected to the underfloor heating actuator.
- *The next numerical output on the WLM master MUST be used for the secondary/boost function.*

Note: To avoid overloading the WLM master, we recommend that the secondary output is used as a signalling function for a remote relay. Please refer to the technical information.

Commissioning mode:

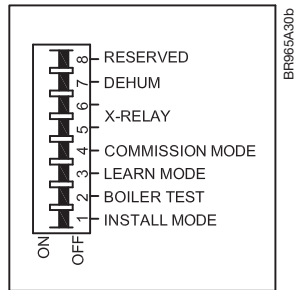
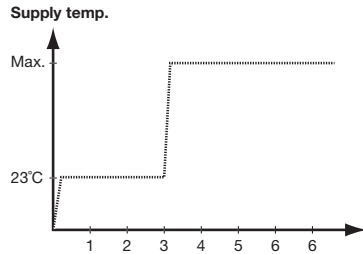

Digital masters include a special “commissioning mode”, which allows the temperature of the supply water to be controlled to assist the drying out of a newly laid concrete floor.

To start this function:

- Set DIP-4 to “on”.
- This will set the supply water temperature at 23c for three days and will fully open all the manifold actuators.
- Then for a further four days the water will be supplied at the maximum supply water temperature, as set in the WLM master menu, and during this period the manifold actuators will remain fully open.
- When the WLM master is operating the commissioning function this is indicated by the output LED’s flashing in rotation and with the word “commissioning” flashing in the display.
- The commissioning function time periods are paused if the power supply is interrupted.
- Should you need to restart the commissioning from the beginning, switch DIP-4 to “OFF” and back to “ON”.
- To de-activate the function switch DIP-4 to “OFF”.

Note: This function conforms to BS/EN-1264 part 4.

Replacing equipment:

Replacing a faulty sensor/controller:

1. Identify the sensor/controller to be changed by the blinking output LED.
2. Switch OFF power to the master
3. Change the sensor/controller.
4. Switch ON power to the master
5. Set the master into learnmode and set DIP-3 to ON.
6. On wireless sensor/controller now press the button on the sensor/controller.
7. Check that the corresponding output LED has changed from blinking to permanently ON.
8. Reset the DIP-3 to OFF.

For any other changes in the system use the quick guide and start the install sequence from the beginning.

Guidelines and Special Features

POWER UP RECOMMENDATIONS

When all connections are complete, we recommend to use the quick guide, setting up system.

System check:

Correct operation of the system can be checked using a special "Install Mode". This enables the installer to individually test and prove each output.

Testing the system:

1. Switch on DIP-3 to activate learn mode: - power light will blink quickly
2. Each red channel light on the master should now be lit if a sensor/controller is present on that channel.
3. Switch off DIP-3 to de-activate learn mode again - power light stops blinking.
4. Turn all adjustable temperature settings on the sensor/controller to minimum.
5. Switch on DIP-1 on the master to activate install mode (Install mode will be active for 2 hours). (Pumps, boiler, mixing valve and actuators should now be off)
6. Turn the temperature setting on the adjustable sensor/controller in room 1 to maximum. The red channel 1 light should be lit and the actuator on output nr. 1 will be activated, and will open after 1-3 minutes, depending on the type of actuator.
Important: If the sensor/controller is of a wireless type a delay of up to 5 minutes may occur before the channel light becomes illuminated .
7. Check that the UHF pump is running and the mixing valve (only FS master) opens .
8. Repeat step 2 on all rooms.
9. Boiler test function:
Switch on DIP-2.
This closes the boiler start relay contacts for 1 minute.
10. To end all tests:
 - Switch off DIP-1 to deactivate Install mode
 - Switch off DIP-2 to deactivate boiler test.
 - Set all temperature knobs to default positions
Room sensors (WLTA, WLTD, WLTM, WLTP) to zero (center position).
Room controllers (WLCT) recommended to 21c.
 - Set all override switches on WLTM and WLTD room sensors to automatic position (clock symbol).

The system is now operating automatically.

Factory Default Settings:

Master	Settings		Factory setting	Own settings
BA/FS	House temperature		21°C	
	Night temperature		18°C	
	Off temperature		5°C	
	Floor Limit temp high		27°C	
	Floor Limit temp low		17°C	
FS	Max water temperature		55°C	
	Weather compensation Cold (winter)	Outdoor temperature	-3°C	
		water temperature	45°C	
	Weather compensation Warm (summer)	Outdoor temperature	25°C	
		water temperature	30°C	

Error Indication

During normal operation the green power LED will be ON when the master control is energised. The red output Channel LED's (1 to 8 on the master, and 9 to 14 on the add-on module) will indicate if the channel output relay is ON/OFF.

An error / fault message is shown by flashing the green power LED or one of the 8 red output Channel LED's. From the number of flashes on any one LED, the problem can be diagnosed, and identified from the following:

The error number will be indicated by the number of flashes, with a pause of less than a 1/2 second between the flashes. The indication will be followed by a pause of 2 seconds, following which the sequence will be repeated. The failure code can also be seen in the service menu on WLM-FS MASTERS (submenu 2).

Flashing Power LED (green)

E1, 1 flash	One or more room sensors, room controllers, WLH, WLAC that are set to channel 0 or channel 15 are no longer sending data to the master control. The fault is corrected by replacing the room sensor. The master will need to be HARD RESET (see below) (NOTE: If the room sensor is of the WIRELESS type, the error/fault message could be an indication that the power has failed, and that the internal battery of the room sensor needs to be replaced)
E2, 2 flashes	One or more room sensors have been set to a channel number which does not exist in the system. For example, the message will occur if the units are set to channels 9-14 and the required add on (AO) module are not found in the system. The error is corrected by setting the channel number of the room sensor to a channel that does exist within the installed master/add on module system.
E3, 3 flashes	Application sensor defect. The fault is corrected by changing the temperature sensor. If the sensor has been removed deliberately to change the operation of the system, follow the HARD RESET instruction below.
E4, 4 flashes	The outdoor compensation module (WLOC) is defective. The fault is corrected by changing the outdoor compensation module. If the module has been removed deliberately to change the operation of the system, follow the HARD RESET instruction below.
E5, 5 flashes	The external Supply limit sensor (type ETF-1899A) is defective. The fault is corrected by changing the temperature sensor. If the sensor has been removed deliberately to change the operation of the system, follow the HARD RESET instruction below.
E6, 6 flashes	Internal overheating. The master has its own internal safety temperature protection system. The problem is corrected by improving the ventilation around the master module.
E7, 7 flashes	Defective internal overheat sensor. The Master will control as normal, however the protection against internal over heating is no longer active. The fault can only be corrected by replacing the master module.
E8, 8 flashes	The communication to the AO module has been lost. The fault is corrected by re-establishing the connection to the AO module or by changing the AO module if it is defective - or if it has been deliberately removed, with a HARD RESET.
E9, 9 flashes	Indicates total number of input units exceeded. Please refer to factory or your local service engineer.
E10, 10 flashes	No connection to wireless receiver, type WLRC-19.
E11, 11 flashes	Step 2 on 2-step controller (WLCT-X9/2) is used by another room sensor/controller.

Only one error/fault condition can be shown at a time. If more than one error occurs, they will be prioritised in the shown sequence (E1, 2, 3...).

Flashing output LED (red):

The appropriate output channel LED can flash, indicating that the room sensor or room controller on that channel has a fault/error. The failure code can also be seen in the service menu (submenu 2a).

- E1, 1 flash The master has lost communication to the room sensor. The fault is corrected by re-establishing the connection to the Room Sensor and the fault condition will be automatically reset once correct communication is resumed. If the room sensor is defective and has to be changed, or if it has been deliberately removed, it is necessary to make a HARD RESET. (NOTE: If the room sensor is of the WIRELESS type, the error/fault message could be an indication that the power has failed, and that the internal battery of the room sensor needs to be replaced)
- E2, 2 flashes The internal sensor in the room sensor/controller is defective. The fault can only be corrected by replacing the room sensor/Controller. Remember to make a HARD RESET after installing the new room sensor/controller.
- E3, 3 flashes The limit sensor on the room sensor/controller is defective. Replace the faulty sensor. Reset is NOT required.
- E4, 4 flashes Defective WLCT room controller. If a room controller operating a group of room sensors becomes defective, the remaining room sensors will continue control within the maximum and minimum limits programmed into the Room controller.
- E5, 5 flashes Two or more room controllers are trying to control this output. Check "AREA" setting on the room controllers.

RESET

There are 2 different reset actions that can be used.

RESET

If the '✓' button is pressed for 5 seconds, a HARD RESET will be initiated. (Indicated by all the red output LED's(1-8) lighting in sequence). This reset will remove from the system any room sensor unit with a defective input sensor, or a defective AO module. The fault message will be reset but the defective items will no longer participate in the system. Once a defective unit is replaced, the new unit will automatically be recognised by the master control and become part of the system. To erase the identity of the defective component from the master memory a HARD RESET must be performed. Hard resets do not alter the temperature settings already programmed into the master control.

FACTORY RESET

If the (✓) button is pressed for more than 15 seconds, a total factory reset will be initiated. This is indicated through flashes of channel LEDs 1,3, 5 and 7 alternating with channel LEDs 2, 4, 6 and 8 (while the "✓" button is pressed).

A factory reset will put all programmed temperature settings back to the factory defaults. It will also remove all room sensors/Controllers from the master memory, and reset the system to accept only those room sensors/Controllers that are functioning correctly.

DEFAULT SETTINGS & SPECIAL FUNCTIONS

The master control has the following default temperature settings:

For the master with display, the setpoints can be altered on the display

DAY SETPOINT	21°C
NIGHT SETPOINT	18°C
OFF (FROST PROTECTION) SETPOINT	5°C
MAX LIMIT	27°C
MIN LIMIT	17°C
MAX SUPPLY WATER TEMP	55°C

Each Room sensor with manual adjustment is capable of increasing or decreasing the preset DAY & NIGHT setpoints on the master by +/- 4C for the heating zone which it is controlling.

The Room controller WLCT has its own DAY & NIGHT temperature settings that can be set separately, and if manual Room sensors are attached to its "group" these will operate to the same settings as the WLCT, but still with the possibility of local $\pm 4^{\circ}\text{C}$ adjustment.

CHANNEL 15 OPERATION

It is possible to override all the automatic functions of the master control, and the Room controllers with a single function. This action is used for holiday periods (e.g. to set the whole system under a frost protection mode), or to temporarily override all the temperature control of the system.

It is achieved by using the any WLTM Room sensor, as this has the override selector. If the cover is removed and the channel selector is set to F (channel 15), that Room sensor will cease to operate its own output channel but will instead operate all the output channels of the system.

Using the WLTM Room sensor, the slide selector on the right side can be used for as follows:

Auto will allow the whole system to operate to the automatic settings.

DAY will keep the whole system working to the DAY Setpoint, but only for those Room sensors that are set for auto.

NIGHT will keep the whole system working to the NIGHT Setpoint, but only for those Room sensors that are set for either auto or day.

OFF will turn the whole system OFF, but still under a frost protection level of 5°C

NIGHT SETBACK (see also EXTERNAL SWITCH)

The external switch or timer function on the master module allows the whole system to be changed from the DAY Setpoint to the NIGHT Setpoint. The external switch must have volt free contacts that are OPEN for NIGHT Setpoint, and CLOSED for DAY Setpoint. The factory fitted link wire is removed when a remote switch/timer is used.

If a WLCT Room controller is employed in a part of the system, the external switch action of going to NIGHT Setpoint will override the Room controller.

Emergency program for room control

- If a Room sensor/controller is defective or if the communication to the unit is interrupted, an alarm will be triggered. Depending on the system configuration the regulation will continue in one of the following ways,
- If there are several units on the same channel which have a room sensor (which is still intact), the regulation will continue as before, however without contribution from the defective unit
- If no valid room sensor/controller is found, the system will run at constantly 20% ON
- If an outdoor sensor is connected, the system will run 40% at 10°C (and Below) decreasing to 0% at 20°C (and above).

The emergency program is only valid for channels with heat control. Channels with cooling control will always run at 100% OFF in connection with a defective room sensor.

Emergency program for supply limit sensor

- If the supply limit sensor is defective, the system will run at constantly 20% on for the valve.
- If an outdoor sensor is connected, the system will run 40% at 10°C (and Below) decreasing to 0% at 20°C (and above).

Exercise of valves

If no automatic on/off sequence of valves or pumps occurs over a 72 hour period, an exercise of these components will take place. The actuators will be activated for 3 minutes. The pumps will be started for 10 secs during that period, and the mixing valve, if fitted will be opened and closed.

INSTRUCTIONS

Add On Module

Configuring the Total System

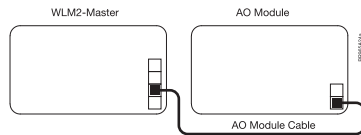

Each master module is capable of controlling 8 heating zones, each of which may use one or more loops of piping, with one or more thermal actuators. These zones are referred to as channels 1 to 8. If you wish to control more than 8 zones, it is necessary to install an ADD ON (AO) modules, each of which can provide another 6 outputs.

The first AO module then controls channels 9 to 14,

Connection of master and add on module

Connect the AO-module, using the special cable included in the box.
Mains supply from 230V fused isolator

Add ON module

INSTRUCTIONS

Outdoor Compensation Module- Type WLOC-19

Outdoor Compensation Module- Type WLOC-19

Introduction

The masters WLM2-1FS and WLM2-3FS are supplied already prepared for weather compensation and simply by adding the outdoor compensation module on the 2-wire bus and using the water temperature sensor on the supply water side, you have a control system for weather compensation. Preset values are programmed at the factory, but these values can easily be adjusted according to local needs via the display on the master. See the user manual "Master with display type WLM" for changing of the default factory settings

Mounting

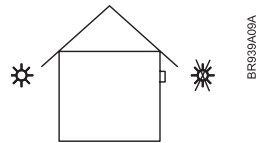

The outdoor compensation module is mounted under the roof eaves, alternative 2-3 m above ground level. Direct sunlight or any other direct heating source such as air ventilation must be avoided. The outdoor compensation module is mounted vertically with the cable entry downwards.

BUS CONNECTION - Outdoor Compensation Module

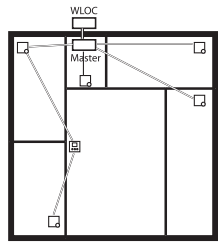

Only OJ Outdoor Compensation Modules type WLOC-19 that are prepared for 2 wire communication can be used.

Standard installation cable, minimum 2 x 0.25 mm² can be used. The outdoor compensation module can be connected in the conventional star wiring format, or in a bus connected mode (Daisy chain). The master has 4 sets of terminals marked Room sensor BUS that can be used for connecting the 2-wire signal from the Room sensors and the outdoor compensation module. There are 4 identical sets of terminals for convenient installation. Any Room sensor / outdoor compensation module can be connected to any pair of terminals. The total length of the 2-wire system can be up to 300 m with a maximum length of 100 m between any 2 Room sensors / outdoor compensation module. Remember to connect + to + and - to -.

Interconnection of WLM2 products:

For easy installation, interconnections between master modules, master and add on modules, and master and wireless receivers, are made by pre-wired plug in connectors (RJ45) For connecting WLM2 add on modules to WLM2 masters, a plug in connector is provided with the add on module. A WLRC wireless receiver is also connected to a WLM2 master, using the plug in connector provided with the receiver.
For connecting a WLM2 master to another master, a plug in connector kit is available.

INSTRUCTIONS

Waterline Wireless System

Waterline Wireless System

Product Programme

WLRC-19 Receiver

Technical Data

Supply Voltage 24 V from Master
Distance to master Max 3 m
Enclosure IP 21
Ambient temperature range 0 to 40°C
Communication Frequency 868 MHz
Communication distance Up to 30 m inside,
. Up to 100 m outside

Connection of Master and Receiver

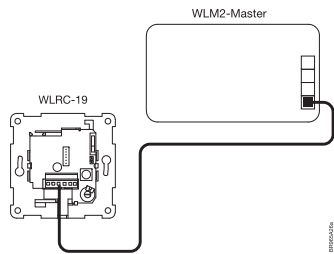

B	A	--	+
Blue	Red	Brown	Yellow

The receiver is connected to the master or the add on module using the included cable.

Max distance between the master/add on module and receiver is 3 m. Up to 5 receivers can be connected. The wiring of the master, add on module and receiver can be made in either a daisy chain or in parallel.

Position

Do not place the receiver inside a metal box. In case of communication problems it may be necessary to move the location of the receiver, or to add an additional receiver.

Master

Connect the receiver to the master, and the system will reconfigure itself for wireless operation.

To set up the system

See Quickguide

INSTRUCTIONS

Type WLCT

Introduction



The room controller type WLCT is part of the underfloor heating system type WLM. The room controller can be set to control one single room, or it can be set as a master to control a group of room sensors (rooms/zones). Here after referred to as area. All the room sensors that are part of that area will follow the times and temperatures programmed into the room controller. For example, if the temperature programmed in the room controller is 22°C, all the room sensors (rooms) belonging to that area will then also be controlled at 22°C. Depending on the types of room sensors used you can adjust the temperature + or -4°C in different rooms, giving a possible room setpoint of +18 to +26°C.

The room controller can be programmed to work at different temperatures during the day allowing lower temperatures during times that the room is unoccupied. Lower temperatures will lower your energy costs without reducing the comfort. All room sensors that are part of the area will follow any new time or temperatures programmed in the room controller.

When it leaves the factory, the room controller has a preset program suitable for most installations. You only need to set the clock and day, and define the room sensors (rooms) that should belong to the area.

The room controller has a pin button marked R (see fig. 1), allowing you, at any time, to reset the room controller to the factory settings. These are listed at the end of this manual with space for you to record your own weekly schedule.

Getting Started

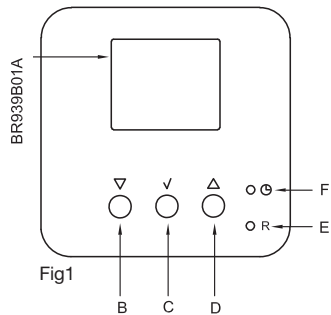

Buttons

A:	B: ▽	C: ✓
Display	Adjustment down	OK - accept

D: △	E: •R	F: ⌚
Adjustment up	Reset to factory setting	Pin button adjust of clock

Display

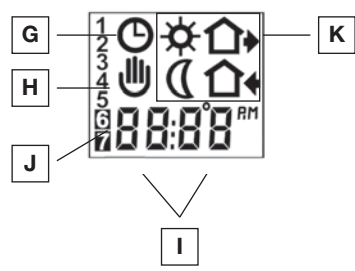

















G:	H:	I:
Automatic mode	Manual mode	Time and temperature

J:	K:
Day number	4-event symbol
	☀ Wake 🏠 Out
	🌙 Night 🏠 Home

Setting the room controller into operation

First time power is connected the clock and day will be flashing and must be set. If you need to adjust the time of the thermostat at a later date, insert a pin into the hole marked  (see fig. 1) for setting of time and day. Adjustment should be made for change in summer and winter time.

	   	Press the UP (△) or DOWN (▽) buttons to select the correct hours and press OK button (✓).	
	   	Press the UP (△) or DOWN (▽) buttons to select the correct minutes and press OK button (✓).	
	   	Then press the UP (△) or DOWN (▽) button to select the correct day and press OK (✓) button.	1-7



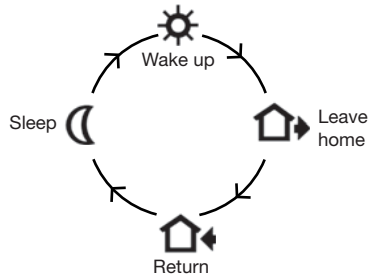

AREA SETUP - see page 40

Daily Use of the room sensor

4-Event Clock Mode

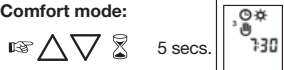

The day has been split into 4 events describing a typical day. When the room sensor is in this 4-event mode it will change the temperature to the required level automatically at the programmed times. As standard the room sensor has 5 days with 4 events (two ON's and two OFF's), and 2 days with 2 events (one ON and one OFF). For programming see page 17. Please, see page 18 - PRO - 4-event sequence to alter the daily event sequence.

4-event clock mode/ automatic mode:		In automatic mode, the clock function symbol (🕒) and one of the 4-event symbols (☀️ 🏠 🏠 🌙) will be indicated. Programming page 17.
Comfort mode: 	Temporary override To temporarily override any temperature in the 4-event schedule program, press the UP (▲) button once, to show the temperature in the display, and press UP (▲) or DOWN (▼) again to increase or decrease the temperature. The display will flash for 5 seconds, and will then revert to the time. The override will operate until the next programmed event when the thermostat will resume the automatic programme.	
	Cancel comfort mode (temporary override) To cancel the temporary override, press the OK (✓) button twice.	
Manual mode: 	Permanent override: During holidays, the scheduled 4-event program can be overridden. Press the OK (✓) button, and then the UP (▲) or DOWN (▼) button until the override temperature is set. The set temperature will remain in the display and the unit will now operate to this temperature permanently.	
	Cancel manual mode To cancel the permanent override state press the OK (✓) button once, and the unit will resume automatic function.	

Programming 4-Event Clock Time and Temperature

For each event, the start time and required temperature needs to be set.

For example, in the morning you wish the heating to start at 07:00 and the temperature to rise to 25°C. Press OK (✓) button for 3 seconds and the start time is displayed. Change this to 07:00 with the UP (Δ) or DOWN (∇) button. Press OK (✓) to confirm.

The temperature is now displayed. Change this to 25°C with the UP (Δ) or DOWN (∇) button. Press OK (✓) button to confirm. This action can now be repeated for the second, third and fourth event.

These settings will be valid for days 1-5 showing on the display. To program the days 6 and 7, repeat the above. Days 6 and 7 are usually Saturday and Sunday, and only have two events (generally morning ON and evening OFF).







































The temperature can be set within the range of +5 to +35°C. It is also possible to select the heating OFF at that event by reducing the setting to 5°C, and then pressing the (∇) once more.



Note that when programming the “Sleep” time (event 4), please ensure that this time is before midnight (00:00).

Press OK (✓) button for 3 secs. to begin programming		
Day 1 - 5		
		☼ : Time and temperature
		🏠 : Time and temperature
		🏠➡ : Time and temperature
		🌙 : Time and temperature
Day 6 - 7		
		☼ : Time and temperature
		🌙 : Time and temperature

Advanced Settings and Read-out

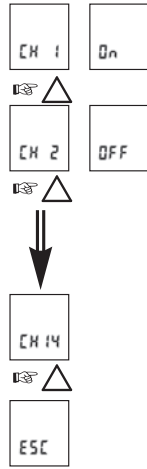

	<p>Press both UP (Δ) and DOWN (∇) buttons together for 3 seconds. INFO is displayed. Continue pressing the UP(Δ) button until you reach one of the desired sub menus, PRO, Hi Li, Scal, and ArEA (For explanations, see below. Select the sub menu with the OK (✓) button.</p>
	<p>INFO - Information The values of the actual measured room temperature and the floor temperature can be seen. The floor temperature is only shown if a floor sensor is installed.</p>
	<div style="display: flex; align-items: center;"> <div style="flex: 1;"> <p>Software version → </p> <p>Room temperature → </p> <p>Floor temperature → </p> </div> <div style="flex: 0.5; text-align: center;"> </div> <div style="flex: 0.5;"> </div> <div style="flex: 1.5; padding-left: 20px;"> <p>Press UP (Δ) or DOWN (∇) button to show the different readouts. No changes can be made here. Use the OK (✓) button to end.</p> </div> </div>
	<p>PRO - 4-event sequence It is possible to change the factory event sequence of Days 1-5 - 4 event, and days 6 & 7 - 2 event. Days 1 to 5 are usually Monday to Friday, whilst days 6 & 7 are usually Saturday & Sunday. An EVENT is either an ON or an OFF operation. You can select from the following sequences which are displayed in the form of a code.</p>
	<div style="display: flex; align-items: center;"> <div style="flex: 1;"> <p>↑</p> <p>↑</p> <p>↑</p> <p>↑</p> <p>↑</p> </div> <div style="flex: 0.5; text-align: center; margin: 0 20px;"> </div> <div style="flex: 0.5;"> </div> <div style="flex: 1.5; padding-left: 20px;"> <p>4 events 5 days, 2 events 2 days indicated by Code 4:52</p> <p>4 events 6 days, 2 events 1 days indicated by Code 4:61</p> <p>4 events 7 days indicated by Code 4:70</p> <p>2 events 7 days indicated by Code 2:70</p> <p>2 events 5 days, 2 event 2 days indicated by Code 2:52</p> <p>Select the required sequence with the OK (✓) button.</p> </div> </div>

  	<p>Hi Li - Floor sensor. Max and min allowed temperature of the floor surface A limit sensor can be connected to the room controller. Max limitation is used for safety to prevent high floor temperatures. For example wooden floor constructions which should not be allowed to exceed a maximum of 27°C. The value can be set from 5°C up to 55°C. The value can also be set to OFF (adjust the temperature to 55°C and push button up once more). Low limitation is used where the temperature of the floor is required never to fall below the minimum set temperature. Example in kitchens or bathrooms with tiles. The value can be set from 5°C up to 55°C. The value can also be set to OFF (adjust the temperature to 5°C and push button down once more). Remember the max limit temperature must be set higher than the min limit temperature. The limit temperatures defined in the room controller will be valid for all the room sensors with limit sensor (type WLTD-19) which are part of the area allocated to the WLCT unit.</p>	
	            	<p>The maximum allowable floor temperature setting is shown. Use the UP (Δ) or DOWN (∇) button to increase or reduce, and OK (✓) button to accept.</p> <p>The display will now show LoLi. Press OK (✓) button to continue.</p> <p>The minimum allowable floor temperature setting. Use the UP (Δ) or DOWN (∇) button to increase or reduce and OK (✓) button to accept.</p>
  	<p>SCAL - Time and temperature scale selection</p>          	<p>You can select either °C or °F scale, and 12 or 24 hour clock as follows:</p> <p>Press UP (Δ) or DOWN (∇) button to change settings. Confirm the required scale with the OK button (✓) button.</p>
  	<p>Adaptive function This function enables the thermostat to calculate when it needs to switch ON so that the required temperature is reached at the set time. With a start time of 07:00 therefore, the thermostat may switch ON as early as 06:00 so that the desired temperature of 25°C is achieved by 07:00. Without this function set, the thermostat will start to heat at the time you set.</p>      	<p>Press the DOWN (∇) button to switch between on and off.</p> <p>Press OK (✓) button to confirm.</p>







	<p>ArEA - (Group of rooms) The rooms that are to be set as part of the WLCT area will follow the temperature settings of the room controller example, an area could be the living room kitchen, and children's rooms having a high room temperature during afternoon and ear evening, and a lower temperature during the early part of the day and at night. Each room sensor will have a channel number, designated CH1, CH2 etc. The appropriate channel number of any room sensor is determined by the numbered output on the master control which is actually switching the valve/actuator for that area.</p> <p>For example, a system may have the kitchen room sensor operating master output # 4, and the childrens room sensor operating master output #5. If the WLCT room controller is then situated in the living room, and operating output #1, then the WLCT need be programmed to control outputs 1, 4, & 5. (Each room sensor will have been set to operate its appropriate output ch see separate instructions).</p> <p>To do this, enter the ArEA sub menu., and press OK (✓) button. CH 1 will be displayed; use the OK (✓) button and then the UP (Δ) button to change the setting to ON. Press OK (✓) and CH 2 is displayed. Use the UP (Δ) button until CH4 is displayed, press OK (✓), and change to ON. Repeat this for CH 5. All three room sensors will now operate under the control of the WLCT room controller.</p> <p>In total up to 14 Channels can be programmed in this way, and it is possible to have more than a single room controller, each own sub room sensors operating to its schedule and temperatures.</p>
	 <p>Set the Channels / Rooms (Ch) to ON if they should follow the settings of this clock thermostat.</p> <p>In total 14 channels / rooms can be controlled.</p>
	<p>ESC - Escape Press OK (✓) button to end programming and to return to scheduled programme.</p> 

Reset to factory Settings - room controllers

Factory reset:

 	Press the pin button R for 3 secs. and the thermostat returns to factory settings. Remember to set time, day and area.
---	---

Factory settings

4-event time and temperature		
Day 1-5	Time	Temperature
	06:00	21°C
	08:00	19°C
	16:00	22°C
	22:30	17°C
Day 6-7		
	08:00	22°C
	23:00	17°C
4-event sequence	4:52	
High limit temperature	27°C	
Low limit temperature	17°C	
Scale	24H,°C	

Type WLCT

INSTRUCTIONS

Waterline Room sensors

Introduction

Fig.1

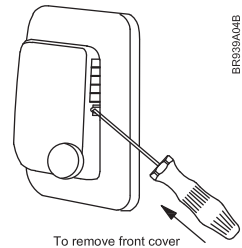
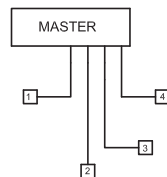
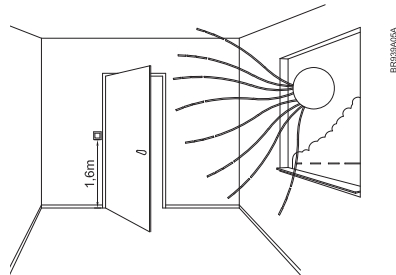
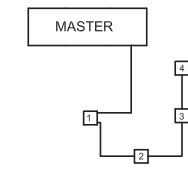

Fig.2



Room sensors connected in star



Room sensors connected in chain (Daisy Chain)

Product programme

WLTP-19/29 Room sensor tamper proof
WLTA-19/29 Room sensor with adjustment
WLTM-19/29 Room sensor with adjustment and mode switch Auto, Day, Night, OFF
WLTD-19/29 Room sensor with adjustment, mode switch Auto, Day, Night, OFF and limit sensor
WLCT2-19/29 Room controller with 4-event clock

Mounting of Room sensor fig. 2

The Room sensor is used for comfort temperature control in rooms. The Room sensor is mounted on an internal wall with free air circulation about 1.6 m above the floor. Draught, direct sunlight, or any other direct heating source must be avoided.

Wired Room sensors

Only OJ Room sensors type WLxx that are suitable for 2 wire communication can be used. Standard installation cable, minimum 2 x 0.25 mm² can be used. The Room sensors can be connected in the conventional star wiring format, or in a bus connected mode (Daisy chain). The master has 3 sets of terminals marked Room sensor BUS that can be used for connecting the 2-wire signal from the Room sensors. There are 3 identical sets of terminals for convenient installation. Any Room sensor can be connected to any pair of terminals. The total length of the 2-wire system can be up to 300 m with a maximum length of 100 m between any 2 Room sensors. Remember to connect + to + and - to - .

Wireless Room sensors

Insert batteries.

Set-up

Fig 3

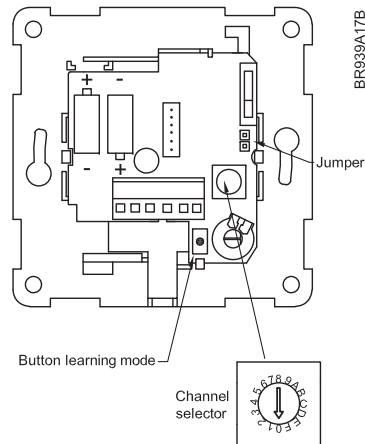

BR939A17B



Button learning mode

Setting up which Room sensor should work with which thermal actuator

Each Room sensor can be selected to operate a specific output which in turn controls the thermal actuators on the manifold. Under the front cover of the Room sensor, a selector can be accessed, and the number of its output (its CH channel) can be set with a screwdriver. Up to 14 channels can be set on the selector, and there are two auxiliary channels with special functions. A WLM master has 8 outputs and additional slave modules each with 6 outputs can be connected creating a system of 14 individual zones.

Please note that channels 10 to 14 are marked as A through E on the selector.

A Room sensor set for CH1 will activate the thermal actuator connected to output 1 on the master. The channel number can be selected without any power connected to the system. The channel of the Room sensor can be changed afterwards if needed. If two Room sensors are placed in the same room and set to the same channel, the temperature control will work according to the average temperature of both Room sensors.

Channel 0:

Each Room sensor is delivered with the switch in position 0 ensuring that it must be set to operate correctly. Channel 0 can also be used for a Room controller controlling a group of Room sensors where the control position could be somewhere central, e.g. the kitchen, rather than in the area where the Room sensors are installed. Setting it to Ch 0 means that times and temperatures are set on the WLCT for the group, but that the WLCT will not control a specific output itself.

Channel 15 (F):

Special function. Further instructions in the user manual.

To set the Room sensors into learning mode

Standard Room sensors without display: Remove the front cover and push the little leaning mode button for approx. 2 sec until the Room sensor give a little "bib"

Room controller with display: Press the clock symbol for 2 sec until it says "init"

The Room sensors will now transmit its unique code in the next 30 seconds, and the system has been set up.

To set up the system for the Master to receive signals from the Room sensors. (Wireless only)

To set the master into learning mode set DIP-X to "on".

The master will now look for new Room sensors that also are in learning mode. Remember to set DIP-X back to "off"...RF LEARNINGMODE.. will be shown in the masters with display.

Setting of Room Temperature

If the WLTM-19 or WLTD-19 Room sensor has been allocated to a WLCT controlled area, then when AUTOMATIC mode has been chosen with the built-in slide switch, the temperature settings will be as programmed in the WLCT Room controller and not in the master, but the same local $\pm 4^{\circ}\text{C}$ adjustment is available.

On the Master WLM2-1FS and WLM2-3FS, if the temperature setting is changed, then the default temperature for all the rooms is changed, but each WLTA, WLTM or WLTD Room sensor is locally adjustable with its own adjustment knob. With this knob the temperature setting from the Master can be increased or decreased by 4°C for that specific room.

The master is supplied with default temperature settings which are used by all non Room sensors that are connected to the system. In Master WLM2-1BA & WLM2-3BA, the DAY temperature setting is fixed at 21°C and the NIGHT temperature is fixed at 15°C .

In Master WLM2-1FS & WLM2-3FS, the DAY, NIGHT and OFF default temperatures are adjustable through the display.

Automatic switching between DAY and NIGHT temperatures is done by either connecting a separate timing device to the master, or using a WLCT Room controller and allocating other Room sensors as part of its group. It is possible to have two or more Room controllers in the system, with each one having its own group of non Room controllers.

Setting of Room sensor Operating Mode

Fig. 3

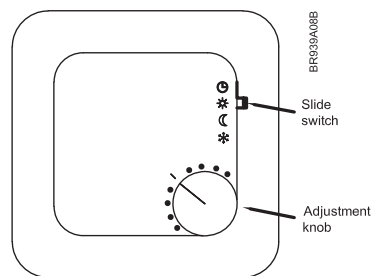

Room sensors type WLTM-19/29 and WLTD-19/29 have a slide switch (see fig. 4) for selecting the mode of operation of the controller. Four different modes can be selected: Auto, Day, Night and OFF.

- ☉ Auto: The controller will follow the temperature settings of the master, or if the Room sensors belongs to a zone group using a WLCT Room controller, it will follow the automatic sequence of temperatures and timings set in the WLCT.
- * Day: It will control the room temperature according to the (DAY) setting defined in the master (typically 21°C).
- ☾ Night: It will control the room temperature according to the (NIGHT) setting defined in the master (typically 17°C).
- * OFF: It will control the room temperature according to the (OFF) setting defined in the master (typically 5°C). This setting is intended to be a "frost protection" mode and is used if the room is to be left unoccupied for long periods.

WLTM-19/29 & WLTD-19/29 are recommended for guest rooms and other infrequently used rooms, as they allow simple override of the automatic timing sequence.

Limit Sensor - WLTD and WLCT

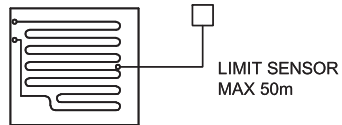

Jumper mounted: max. limitation
 Jumper removed: min. limitation

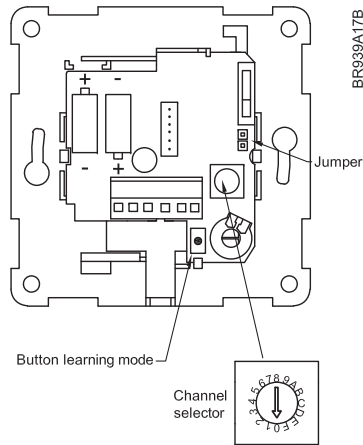

Room sensors/controllers with a limit sensor have a mechanical jumper on the printed circuit board allowing the limitation to be set for MIN. or MAX. temperature control. If set for MAX., it will have a temperature setting of 27°C. Set for MIN., it has a setting of 17°C. These temperature are fixed when used with masters WLM-1BA or WLM-3BA unless the Room sensor has been allocated to a zone group controlled by a WLCT Room controller. In this case, the limit settings can be increased or decreased by accessing the Room controller. The limits then set will apply to all relevant Room sensors with limit sensors belonging to that group. If the master WLM-1FS or WLM-3FS is used, the limit settings can be changed through the programming buttons on the master.

Mounting of limitation sensor

Max. temperature limitation is used to protect the floor area from becoming too warm. This may be required if special floor surfaces (real wood) are used. The sensor should be positioned where it can read the true temperature of the floor and should always be within the heated area.

Min. temperature limitation is used to keep a floor surface warm, irrespective of room temperature. For example, water on tiled bathrooms or pool areas with dry more quickly if the floor surface is kept warm. The sensor should be positioned where it can read the true temperature of the floor and should always be within the heated area.

For easy replacement we recommend that all floor sensors are mounted in a tube which is placed between 2 heating pipes. The inner end of the tube should be sealed, and the sensor cable brought back to the wall edge. If required, the sensor cable can be extended up to 50 m with a standard installation cable.

WLTM: Use of external room sensor

A remote room sensor can be used instead of the built-in sensor by connecting the jumper across the two pin bridge on the printed circuit board under the Room sensor cover. From factory the jumper is “parked” on one pin. Location of jumper see fig. 3.

Technical Data (Wireless)

Supply Voltage Batteries, 2 x AAA Alkaline 1,5 V
 Distance to master Max 30 m
 Enclosure IP 21
 Ambient temperature range 0 to 40°C
 Communication frequency 868 MHz
 Communication distance Up to 30 m inside,
 Up to 100 m outside

Batteries (Wireless)

The Room sensors use 2 x AAA batteries type Alkaline. A lifetime of 1-2 years is expected. The Room sensors are equipped with a low battery alarm giving a little bip each 5 minutes in case of low battery. If a Room sensor is defective or if the communication to the unit is interrupted, an alarm will be triggered on the master, and the room will be heated at constantly 20% as safety. The alarm can be overruled in the next 24 hours. On the Room controller press the clock symbol for 2 sec. On the other Room sensors remove the front cover and press the little learning mode button for 2 seconds.



OJ ELECTRONICS A/S
STENAGER 13B
DK-6400 SØNDERBORG
DENMARK
T.+45 73 12 13 14
F.+45 73 12 13 13
OJ@OJ.DK
WWW.OJ.DK

OJ ELECTRONICS UK
CRUSADER PARK
WARMINSTER
WILTSHIRE, BA12 8SP
UNITED KINGDOM
T.+44 01985 213 003
F.+44 01985 213 310
SALES@OJUK.CO.UK
WWW.OJUK.CO.UK

OJ ELECTRONICS

taking comfort further